

FOX METER, INC

INSTRUMENTATION FOR INDUSTRY

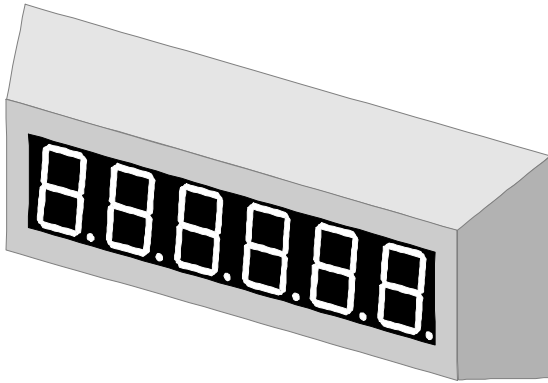

FA300 Series

High performance panel instruments
 uP based electronics, easily modified
 for those special applications that involve
 communications, counting, timing, speed or display

Functional Choices

- **FA310 - Universal remote display:** ASCII RS232, RS422, current loop or parallel BCD, menu selectable firmware drivers for many scales and intelligent sensors
- **FA320 - Clock remote:** ASCII remote display with lighted colons for use with F390 master clock
- **FA330 - Dual counter:** scaleable, < 2KHz pulsed or contact, non-contending dual count inputs
- **FA340 - Universal counter:** scaleable, bi-directional, quadrature, < 50 KHz pulsed or contact
- **FA350 - Rate meter / tachometer:** hour, minute, second and variable time base, fully scaleable rate
- **FA360 - Frequency meter:** 1 Hz to 10 MHz, decade shift menu selectable, precision gated counter
- **FA370 - Decade timers:** selectable time base from hours to .0001 seconds, 11 selectable modes
- **FA380 - HH:MM:SS timer:** like the F370 there are 11 program selectable control modes
- **FA390 - Master clock:** 12 or 24 hour, date modes, accurate time keeping to 2099!

General Specifications

Base meter

- **Display** - 1" tall 6-digit tri-color LED
- **Bezel** - stainless steel
- **Display window** - non-glare glass with silicone seal
- **Sealing** - NEMA 4X gasketing standard
- **Controls** - setup menu is accessed via switches located on rear of meter
- **Connections** - socketed screw terminal connectors
- **Remote control inputs** - various functions available based on meter function
- **Viewing distance** - up to 50 feet
- **Operating temperature** - -55°C to +85°C

Outputs

- **Serial ASCII** - RS232, RS422/485, current loop
- **Parallel BCD** - 5 word / bit modes
- **Analog** - 4 To 20 mA, 1-5 V
- **Relay** - up to 4 setpoints, 200V @ 1A relay outputs require 1 F000-920 master setpoint module and up to 3 F000-924 slave setpoint modules

Power supplies

- **120 VAC** - 50 / 60 Hz, 20 mA Maximum
- **120 VAC** - With Battery Backed Data
- **220 VAC** - 50 / 60 Hz, 10 mA Maximum
- **12 to 30 VDC** - 50 mA Maximum
- **12 To 30 VDC** - With Battery Backed Data

FA300 Series Mechanical Specifications

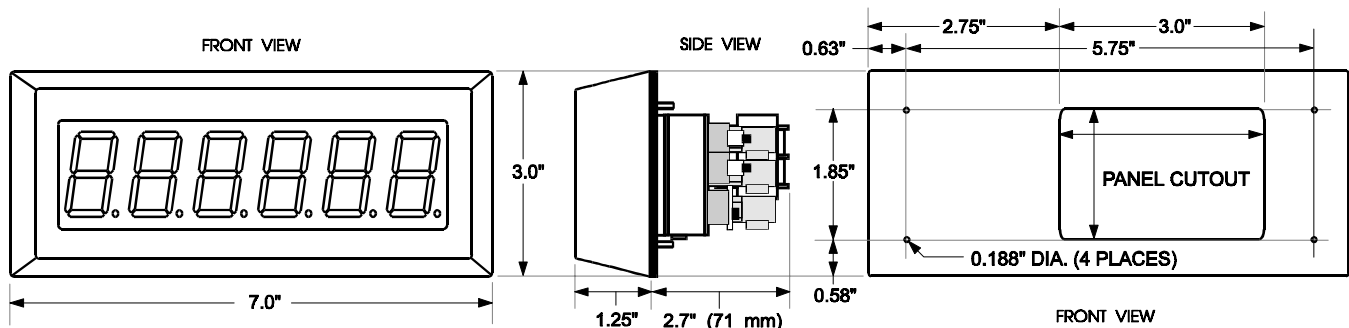

FA300 Series

1" 6-Digit Tri-Color

(Display, Clock, Timer, Counter, Frequency)

Model numbers consist of two prefix letters, a family number, a function number, a power supply number, and a three digit I/O configuration number. Family number 3 indicates base meter, family number 4 indicates the addition of the setpoint interface.

BASE METER OPTIONS



FA[31] - Universal remote display.....	\$485	FA[41] - Universal remote display.....	\$540
FA[32] - Clock remote.....	\$510	FA[42] - Clock remote.....	\$565
FA[33] - Dual counter.....	\$550	FA[43] - Dual counter.....	\$570
FA[34] - Universal counter.....	\$550	FA[44] - Universal counter.....	\$570
FA[35] - Rate meter / tachometer.....	\$555	FA[45] - Rate meter / tachometer.....	\$575
FA[36] - Frequency meter.....	\$555	FA[46] - Frequency meter.....	\$575
FA[37] - Decade timers.....	\$520	FA[47] - Decade timers.....	\$575
FA[38] - HH:MM:SS timer.....	\$520	FA[48] - HH:MM:SS timer.....	\$575
FA[39] - Master clock.....	\$530	FA[49] - Master clock.....	\$585

POWER SUPPLY OPTIONS

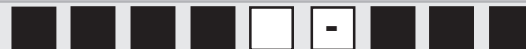

[1] - 120 VAC 50 / 60 Hz.....	\$0
[3] - 240 VAC 50 / 60 Hz.....	\$25
[4] - 24VDC linear with heatsink.....	\$20
[7] - 12 VDC to 30 VDC.....	\$37
[8] - 120 VAC with battery backed data.....	\$42
[9] - 12 to 30 VDC with battery backed data....	\$79

INPUT / OUTPUT OPTIONS



[651] - RS232C serial ASCII data.....	\$29
[652] - RS422 serial ASCII data.....	\$20
[653] - RS485 4-wire serial ASCII data.....	\$40
[655] - Isolated current loop ASCII data.....	\$60
[657] - RS232C and RS232C auxillary.....	\$149
[658] - RS232C and RS422 auxillary.....	\$140
[659] - No data inputs / no outputs.....	\$0
[661] - RS232C and 4 to 20 mA analog out.....	\$194
[662] - RS422 and 4 to 20 mA analog out.....	\$185
[665] - C/L and 4 to 20 mA analog out.....	\$225
[671] - RS232C and parallel data out.....	\$116
[672] - RS422 and parallel data out.....	\$107
[675] - C/L and parallel data out.....	\$147
[681] - RS232C and parallel data in.....	\$116
[682] - RS422 and parallel data in.....	\$107
[685] - C/L and parallel data in.....	\$147
[691] - Isolated 4 to 20 mA output.....	\$165
[692] - Parallel data outputs sinking.....	\$87
[693] - Parallel data inputs sinking.....	\$87
[694] - Parallel data outputs sourcing.....	\$87
[695] - Parallel data inputs sourcing.....	\$87